

Spiegelberg:

Technology for brains

8F ventricular drainage catheter with
cranial bolt

EVD30.014.01

10F ventricular drainage catheter with
cranial bolt

















EVD30.034.01

Instructions for use

Content

Symbols used	4
General information	4
Technical data	5
Contents of the original packaging.....	5
Approved accessories	5
User group and environment	5
Indications and intended use	6
Contraindications	6
Warnings	6
MRI safety information	7
Application & handling	8
Preparation of the ventricular catheter.....	8
Preparation of the application area	8
Insertion of the ventricular catheter.....	9
Connection to an EVD set	10
Checking the function of the ICP probe	10
Drainage of CSF	10
Disconnecting the EVD set.....	10
Replacing the EVD set.....	10
Closing the wound	10
Determining the position of the ventricular catheter.....	11
Removal of the ventricular catheter	11
Disposal.....	11
Returns policy	11

Symbols used

	Item number		Do not use if packaging is damaged.
	Batch number		Upper temperature limit
	Sterilised with ethylene oxide		Caution!
	Do not reuse		Observe instructions for use
	Store in a dry place		Use by
	Keep away from sunlight		Date of manufacture
	Product complies with the requirements of European Directive 93/42/EEC		Manufacturer
	Information note		MR conditional

General information

The instructions for use must be read carefully before use. The product may only be used in accordance with the intended purpose. The manufacturer accepts no liability or warranty for damages caused by improper use or failure to observe the instructions for use.

The product may only be used if the sterile packaging is intact prior to first opening. The product must be transported and stored in a dry place. The following temperatures must be maintained in order to avoid influencing the product properties:

- Transport temperature: up to +50 °C
- Storage temperature: Room temperature
- Ambient temperature for application: Room temperature up to +50 °C

The product is intended for single use only and may not be reused. Reprocessing can lead to the destruction of the product or changes in the product properties. Safe use is therefore no longer guaranteed.

The product must not be cleaned. Only the hose may be moistened with isotonic NaCl solution.

The numbers in brackets refer to the illustration of the product in these instructions for use. The term “distal” means far from the patient and the term “proximal” means close to the patient. Furthermore, the term “ventricular catheter” is used as an umbrella term for “ventricular drainage catheter” in the following.

Technical data

The stated values reflect nominal values and may differ.

REF / Order number	EVD30.014.01	EVD30.034.01
Outer diameter	2.7 mm (8F)	3.3 mm (10F)
Drainage lumen inner diameter	1.5 mm	1.9 mm
Drainage hose total length	270 mm	270 mm
Drainage opening diameter	1.2 mm	1.7 mm
Number of openings	16	16
Depth markings*	50 - 70 mm* (in 5 mm intervals)	50 - 70 mm* (in 5 mm intervals)
Application duration	Short term up to 30 days	Short term up to 30 days
Material	Radiopaque polyurethane	Radiopaque polyurethane

* The depth markings are printed twice. The proximal markings are used to align the ventricular catheter in the bolt. 70 mm alignment on the bolt means 70 mm actual depth in the brain.

Contents of the original packaging

- 1 ventricular drainage catheter
- 1 Luer lock connector
- 1 cranial bolt
- 1 drill with depth marking (drilling diameter: 5.3 mm)
- 1 Allen key
- 1 dura opener
- 1 mandrel
- 1 end cap
- 1 instruction manual

Double packed
EO sterilised
For single use only

Approved accessories

- EVD30.001.01/FV800P External ventricular drainage set (EVD set)
- EVD30.004.01 External ventricular drainage set (EVD set) with plate and clamp
- EVD30.106.01 External ventricular drainage bag

User group and environment

The ventricular catheter may only be positioned by a neurosurgeon. Further handling can be done by persons, who have completed medical training and have experience in dealing with neurological trauma (intensive care nurses).

The products are intended exclusively for use in professional healthcare facilities.

Indications and intended use

The ventricular catheter drains cerebrospinal fluid (CSF) in adults for the temporary reduction and control of intracranial pressure and/or sanguineous CSF. The proximal end is inserted into the ventricle for this purpose. The distal end is connected to a droplet chamber system (EVD set) or a drainage bag.

CSF drainage is indicated for the following conditions, for example: traumatic brain injuries, acute hydrocephalus, subarachnoid haemorrhage (SAH), tumours and inflammatory conditions of the medulla oblongata.

Contraindications

The ventricular catheter must not be used for purposes other than those specified. Components that have come into contact with infected tissue should not be used further.

Use is always contraindicated in cases of scalp infections, patients receiving anticoagulant therapy and increased bleeding tendency. It is also contraindicated when continuous monitoring by trained personnel cannot be guaranteed.

Warnings



Possible complications when using the ventricular catheter include dislocations, bleeding and infections.



Care and caution should be exercised when handling the ventricular catheter.



Do not pull on or jerk the ventricular catheter quickly! Quickly pulling on or jerking the probe can damage the hose.



Avoid kinks in the hose, as this will impair the drainage.



The ventricular catheter must be checked for completeness prior to use. If the product is not complete, the ventricular catheter must not be used.



The Luer lock connector (11) must not be disinfected or moistened, as the material may become brittle. This may result in a loss of function of the ventricular catheter.









The depth of the ventricular catheter can be checked using the marked scale (2) and the metal piece (3) on the scale. The metal piece on the scale (3) is used to secure the ventricular catheter at a suitable depth with the cranial bolt (9+10).



The scale (2) is shown twice: the proximal scale indicates the insertion depth from the cranial bone; the distal scale is used to determine the depth after securing the cranial bolt (9+10).



The ventricular catheter must be protected from sunlight and kept away from sources of radiation. Radiation can lead to a deterioration in material properties and thus to the failure of the device functionality.

-  An open or damaged system must not be used further and must be replaced! Otherwise there is a risk of infection or loss of function.
-  The mandrel (4) must not be inserted into a ventricular catheter which has already been positioned. This poses a risk of injury!
-  No liquids or drugs may be administered via the ventricular catheter.
-  Check the connections for leaks on a regular basis. Should there be a leaking connection, this poses a risk of contamination or overdrainage.
-  The procedure for using the ventricular catheter must be observed and followed in the correct order.
-  The position of the ventricles should be checked using imaging techniques prior to application.
-  Contaminated components and ventricular catheters must not be reused.

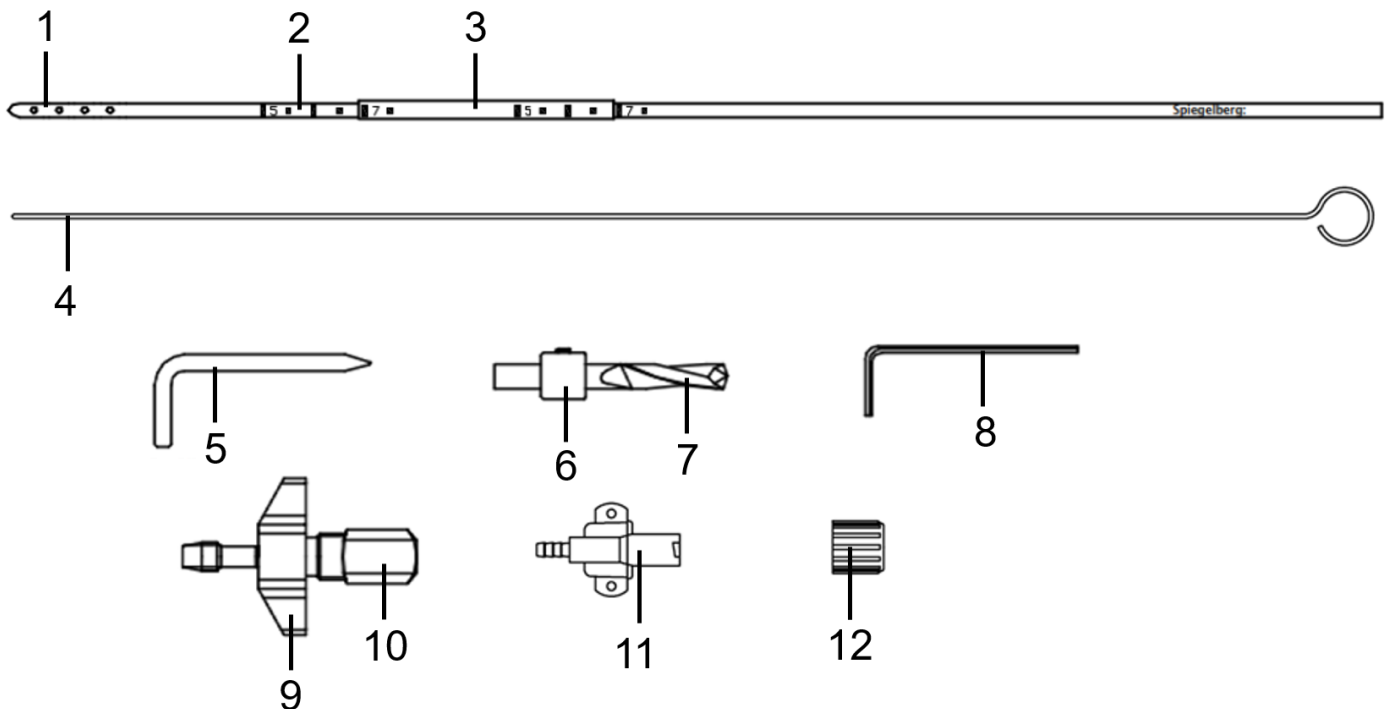

EVD30.014.01 / EVD30.034.01



MRI safety information

Non-clinical testing has shown that the “Intracranial Pressure and Catheter System” is “MR conditional”. A patient with this product can be safely scanned in an MRI system meeting the following conditions:

- static magnetic field of 1.5 - 3 tesla with
- maximum spatial field gradient of 2,300 G/cm (23 T/m)
- maximum force product of 38,000,000 G²/cm (38 T²/m)
- theoretically estimated whole body averaged (WBA) specific absorption rate (SAR) < 2 W/kg (Normal Operating Mode).

Under the scanning conditions defined above, the “Intracranial Pressure and Catheter System” is expected to produce a maximum temperature rise of less than

- 2.8 °C (2 W/kg, 1.5 tesla) with an ambient temperature increase of approximately 1.1 °C (2 W/kg, 1.5 tesla)¹
- 2.7 °C (2 W/kg, 3 tesla) with an ambient temperature increase of approximately 0.8 °C (2 W/kg, 3 tesla)²

after 15 minutes of continuous scanning.

In non-clinical tests, the image error generated by the product is around 70.9 mm for the product family worst case³ when the image is generated using a gradient echo pulse sequence and a 3 tesla MRI.



WARNINGS according to the MRI safety information

- Patient injuries can occur if the conditions for safe use in rooms designated as MRI environments are not observed.
- Never exceed a maximum whole body averaged (WBA) specific absorption rate (SAR) of 2 W/kg during MRI measurement (Normal Operating Mode).
- Make sure that all components of the EVD set used with the ventricular catheter are “MR safe” or “MR conditional” at 1.5 or 3 tesla.
- Do not bring catheter accessories (mandrel, 4, dura opener, 5, drill, 6+7, and Allen key, 8) into the MRI environment.

Application & handling

Preparation of the ventricular catheter

The ventricular catheter should be checked for completeness prior to use.

The insertion depth of the ventricular catheter should be determined using imaging techniques prior to insertion.



WARNING! There is a risk of tissue damage if the ventricular catheter is inserted too far.



NOTE! If the printed image on the scale (2) is not clearly legible, another ventricular catheter must be used.

Preparation of the application area



NOTE! The appropriate insertion site and technique must be selected by the surgeon.



NOTE! The supplied drill (7) with depth mark (6) must be used to place the drill hole.

¹ RF-related temperature increase for probe 3PS (REF: SND13.1.63/FV535P); worst case on behalf of the whole “Intracranial Pressure and Catheter System” under the aforementioned scanning conditions

² RF-related temperature increase for Silverline® ventricular drainage catheter with cranial bolt (REF: EVD30.014.02); worst case on behalf of the whole “Intracranial Pressure and Catheter System” under the aforementioned scanning conditions

³ Determined using the Silverline® ventricular drainage catheter with cranial bolt (REF: EVD30.014.02); worst case on behalf of the whole “Intracranial Pressure and Catheter System”.

1. Perform aseptic preparation of the surgical area and put up surgical drapes.
2. Open up the scalp.
3. Remove the protective hose from the drill (7).
4. Loosen the depth mark (6) with the Allen key (8).
5. Adjust the depth mark (6) on the drill (7).
6. Tighten the depth mark (6) firmly with the Allen key (8) to prevent slipping.
7. Insert the drill (7) into a hand brace.
8. Place the drill hole.
9. Clean the drill hole completely to remove any chips, splinters and bone fragments.
10. Remove the protective hose from the dura opener (5). Incise the dura using the dura opener (5).
11. Place the end cap (12) on the plastic end of the Luer lock connector (11).



WARNING! Care should be taken during drilling and when opening the dura to avoid drilling too deep and damaging the dura.



WARNING! The mandrel (4) may not be used to open the dura. This may cause damage to the tissue or to the mandrel (4).



NOTE! If the drill hole is too small, it will not be possible to insert the cranial bolt (9+10) or insertion will not be possible without causing damage.



NOTE! If the drill hole is not cleaned completely to remove any chips, splinters and bone fragments, the ventricle catheter may be damaged during insertion.

Insertion of the ventricular catheter



NOTE! The mandrel (4) must be used for the insertion of the ventricular catheter. Otherwise there is a risk of the hose kinking or rolling up.



NOTE! The ventricular catheter must be inserted at a minimum depth of 50 mm and a maximum depth of 70 mm. Otherwise, there is a risk that the lumen will be pinched when tightening the clamping nut (10).

1. Loosen the clamping nut on the cranial bolt (10) by turning it counter clockwise until the clamping nut (10) is loose. Ensure that the clamping nut (10) is not removed entirely.
2. Insert the mandrel (4) into the ventricular catheter.
3. Push the ventricular catheter through the clamping nut on the cranial bolt (10) until the metal piece (3) emerges completely from the bolt.
4. Positioning the ventricular catheter in the ventricle.
5. Check the correct positioning based on the flow of cerebrospinal fluid.
6. Insert the cranial bolt (9+10) into the drill hole by turning it clockwise. To do this, turn the bolt using the bolt wings (9).
7. Determine the correct depth using the printed scale (2) and the metal piece (3).
8. Remove the mandrel (4).
9. Tighten the clamping nut (10) by turning it clockwise until the ventricular catheter is secure.
10. Push the distal end of the ventricular catheter over the entire length of the metal part of the Luer lock connector (11).
11. Secure the ventricular catheter onto the Luer lock connector (11) using the suture wing.



WARNING! In the event that a component becomes partially or completely detached from the hose during use, the ventricular catheter must be replaced and the detached parts removed, for example in order to prevent a rejection reaction.



WARNING! The mandrel (4) must not be inserted into a ventricular catheter which has already been positioned. This poses a risk of injury! If the mandrel (4) is to be reinserted, the ventricular catheter must be pulled out and then reinserted.

Connection to an EVD set

1. Remove the end cap (12) from the Luer lock connector (11).
2. Connect the Luer lock connector (11) to the connector on the EVD set.
3. Turn the Luer lock connector (11) until significant resistance can be felt and the connection is secure.
4. Perform a visual check for leaks and function.



NOTE! Visual checks of the connection to the EVD set must be carried out on a regular basis.

Checking the function of the ICP probe

Check the function of the ventricular catheter using the CSF flow.



NOTE! Where there is no flow of CSF, this indicates a blockage, kink or constriction. In the event of a blockage, the ICP probe must be replaced.

Drainage of CSF

CSF in the ventricle passes through the drainage holes (1) into the EVD set via the ventricular catheter. If there is no flow of CSF, the hose system must be checked for kinks or constriction.



NOTE! Kinks and constriction in the ventricular catheter must be avoided to prevent drainage restrictions.

Disconnecting the EVD set

1. Turn the Luer lock connector (11) counter clockwise.
2. Quickly cap the Luer lock connector (11) with the end cap (12).

Replacing the EVD set

1. Disconnect the Luer lock connector (11) and the EVD set.
2. Quickly cap the Luer lock connector (11) with the end cap (12).
3. Replace the EVD set according to the manufacturer's instructions.
4. Remove the end cap (12) from the Luer lock connector (11).
5. Connect the Luer lock connector (11) to the EVD set.

Closing the wound

After the proper function of the ventricular catheter has been confirmed, the wound on the scalp can be closed. The technique and material used for this are to be determined by the surgeon.

- i** **NOTE!** When closing the wound, care must be taken not to damage the ventricular catheter.

Determining the position of the ventricular catheter

The position of the ventricular catheter can be checked using imaging techniques.

- i** **NOTE!** The correct positioning of the ventricular catheter and the condition of the patient must be checked at regular intervals.

Removal of the ventricular catheter

- i** **NOTE!** Proceed slowly and carefully when removing the ventricular catheter. It must be ensured that no tissue is damaged and that the suture wing on the Luer lock connector (11) has been detached.

- i** **NOTE!** The ventricular catheter must not be removed in a fast and jerky manner in order to avoid injuries and prevent blood, CSF and possibly tissue from being sprayed around.

- i** **NOTE!** The ventricular catheter must not be pulled over sharp or uneven edges during removal to avoid damaging the hose and possibly tearing the ventricular catheter.

1. Disconnecting the ventricular catheter and the EVD set.
2. Loosen the fixings attaching the ventricular catheter to the patient.
3. Fully loosen the clamping nut on the cranial bolt (10).
4. Pull out the ventricular catheter.
5. Check that the ventricular catheter has been removed completely and that the tissue has not been damaged.
6. Remove the cranial bolt (9+10).
7. Observe the condition of the patient.

- i** **NOTE!** No components of the ventricular catheter may be left in the patient.

- i** **NOTE!** If the cranial bolt (9+10) cannot be loosened, it must not be loosened by force; instead, loosen the bolt by moving it back and forth gently.

Disposal

After use, the product should be disposed of in accordance with the regulations for infectious waste and/or in accordance with national or regional regulations.

Returns policy

Before returning a product, approval must be obtained from the customer service department. Returns will not be accepted unless the return has been approved in advance by Spiegelberg in the context of a complaint or a return has specifically been requested.

Contaminated/used products must be packaged in a bag for biological hazardous substances for return shipment.



Manufacturer:
Spiegelberg GmbH & Co. KG
Tempowerkring 4
21079 Hamburg
Germany

Tel.: +49-40-790-178-0
Fax: +49-40-790-178-10
E-mail: info@spiegelberg.de
<http://www.spiegelberg.de>

Subject to technical changes.
Version: 12 / 2020-11-09



0297

© by Spiegelberg GmbH & Co. KG 2020