



Probe 3  
Probe 3XL

















**SND13.1.13/FV532P**  
**SND13.1.13XL/FV533P**

Instructions for use

# Content

Symbols used .....	3
General information .....	3
Technical data .....	4
Contents of the original packaging.....	4
Approved accessories .....	4
User group and environment .....	4
Indications and intended use .....	5
Contraindications .....	5
Warnings .....	5
MRI safety information .....	7
Application & handling .....	8
Preparing the ICP probe .....	8
Preparation of the application area .....	8
Inserting the ICP probe.....	8
Determining the position of the ICP probe .....	9
Attaching the ICP probe.....	9
Connection to an EVD set .....	9
Connection to the ICP monitor.....	10
Checking the function of the ICP probe .....	10
Drainage of CSF .....	10
Disconnecting the EVD set .....	10
Replacing the EVD set.....	10
Closing the wound .....	11
Removing the ICP probe .....	11
Disposal.....	11
Returns policy .....	11

## Symbols used

	Item number		Do not use if packaging is damaged.
	Serial number		Upper temperature limit
	Sterilised with ethylene oxide		Caution!
	Do not reuse		Observe instructions for use
	Store in a dry place		Use by
	Keep away from sunlight		Date of manufacture
	Product complies with the requirements of European Directive 93/42/EEC		Manufacturer
	Information note		MR conditional
	HDM connector marking stands for monitor connection		

## General information

The instructions for use must be read carefully before use. The product may only be used in accordance with the intended purpose. The manufacturer accepts no liability or warranty for damages caused by improper use or failure to observe the instructions for use.

The product may only be used if the sterile packaging is intact prior to first opening. The product must be transported and stored in a dry place. The following temperatures must be maintained in order to avoid influencing the product properties:

- Transport temperature: up to +50 °C
- Storage temperature: Room temperature
- Ambient temperature for application: Room temperature up to +50 °C

The product is intended for single use only and may not be reused. Reprocessing can lead to the destruction of the product or changes in the product properties. Safe use is therefore no longer guaranteed.

The product must not be cleaned. Only the tube may be moistened with isotonic NaCl solution.

The numbers in brackets refer to the illustration of the product in these instructions for use. In the following, both products are referred to as ICP probes. If there are additions or exclusions for a product, this is denoted by indicating the reference number. The term “distal” means far from the patient and the term “proximal” means close to the patient.

## Technical data

The stated values reflect nominal values and may differ.

REF / Order number	SND13.1.13/FV532P	SND13.1.13XL/FV533P
Outer diameter	2.3 mm (7 F)	3.0 mm (9 F)
Drainage lumen inner diameter	1.0 mm	1.6 mm
Drainage tube total length	270 mm	270 mm
Implantable length	130 mm	130 mm
Probe total length	1500 mm	1500 mm
Drainage opening diameter	1.0 mm	1.6 mm
Number of openings	4	4
Depth markings	50 – 100 mm (in 5 mm intervals)	50 – 100 mm (in 5 mm intervals)
Filling volume	< 0.15 ml	< 0.15 ml
Application duration	Short term up to 30 days	Short term up to 30 days
Material	Polyurethane	Polyurethane

## Contents of the original packaging

- 1 probe 3 / 3XL
- 1 stylet
- 1 butterfly suture clamp
- 1 Luer lock connector
- 1 cap
- 1 instruction manual

Double packed  
EO sterilised  
For single use only

## Approved accessories

- HDM26.1 ICP monitor (230 V and 115 V)
- HDM29.1 ICP monitor with battery (230 V and 115 V)
- HDM29.2 ICP monitor
- EVD30.001.01/FV800P External ventricular drainage set (EVD set)
- EVD30.004.01 External ventricular drainage set (EVD set) with plate and clamp
- EVD30.106.01 External ventricular drainage bag

## User group and environment

The ICP probe should only be positioned by a neurosurgeon. Further handling can be done by persons, who have completed medical training and have experience in dealing with neurological trauma (intensive care nurses).

The products are intended exclusively for use in professional healthcare facilities.

## Indications and intended use

The ICP probe is used for the measurement of intracranial pressure (ICP) in adults with an air chamber (2) attached to the proximal tip of a double-lumen catheter and the drainage of cerebrospinal fluid (CSF). The air lumen (4) transmits the pressure to the ICP monitor. The drainage lumen (6) is used for the drainage of CSF.

The air chamber system is a hollow body made of plastic (2) which is connected to a pressure transducer via a tube (4) and a connector (5). The pressure transducer is located in the ICP monitor together with the measuring electronics and a device for filling the air chamber (2).

ICP measurement and CSF drainage are indicated in the following clinical pictures, among others: severe craniocerebral trauma, subarachnoid haemorrhage, encephalopathy, hydrocephalus, intracranial haemorrhage as well as postoperative brain swelling. ICP probes are used to measure pressure when ICP must be continuously monitored and can be used for the drainage of CSF.

## Contraindications

The ICP probe must not be used for purposes other than those specified. Components that have come into contact with infected tissue should not be used further.

Use is always contraindicated in cases of scalp infections, patients receiving anticoagulant therapy and increased bleeding tendency. It is also contraindicated when continuous monitoring by trained personnel cannot be guaranteed.

## Warnings



Possible complications when using the ICP probe include dislocation, bleeding and infection.



Care and caution should be exercised when handling the ICP probe.



Do not pull on or jerk the ICP probe quickly! Quickly pulling on or jerking the probe can damage the tube.



Avoid kinks in the tube, as this will impair the measuring function and drainage.



The ICP probe must be checked for completeness prior to use. If the product is not complete, the ICP probe must not be used.



No sharp or pointed objects may be placed near the air chamber (2). These pose a risk of damage to the air chamber (2), resulting in leakage.



The air chamber (2) must be handled with care.



The air chamber (2) may only be moistened with isotonic saline solution.



The depth of the ICP probe can be checked using the marked scale (3).



The ICP probe must be protected from sunlight and kept away from sources of radiation. Radiation can lead to a deterioration in material properties and thus to the failure of the device functionality.



An open or damaged system must not be used further and must be replaced! Otherwise there is a risk of infection or loss of function.



Only ICP monitors from Spiegelberg may be used for ICP measurements.



It is essential that the supplied components are used as compatibility with the ICP probe is guaranteed.



The stylet (7) must not be inserted into an ICP probe which has already been positioned. This poses a risk of injury!



Contaminated components and ICP probes must not be reused.



No liquids or drugs should be administered via the drainage lumen (6) on the ICP probe.



The HDM connector (5) must not be disinfected or moistened, otherwise the filter inside will clog.



Check the connections for leaks on a regular basis. Should there be a leaking connection, this poses a risk of contamination or overdrainage.



The procedure for using the ICP probe must be strictly observed and followed in the correct order.



The position of the ventricles should be checked using imaging techniques prior to application.

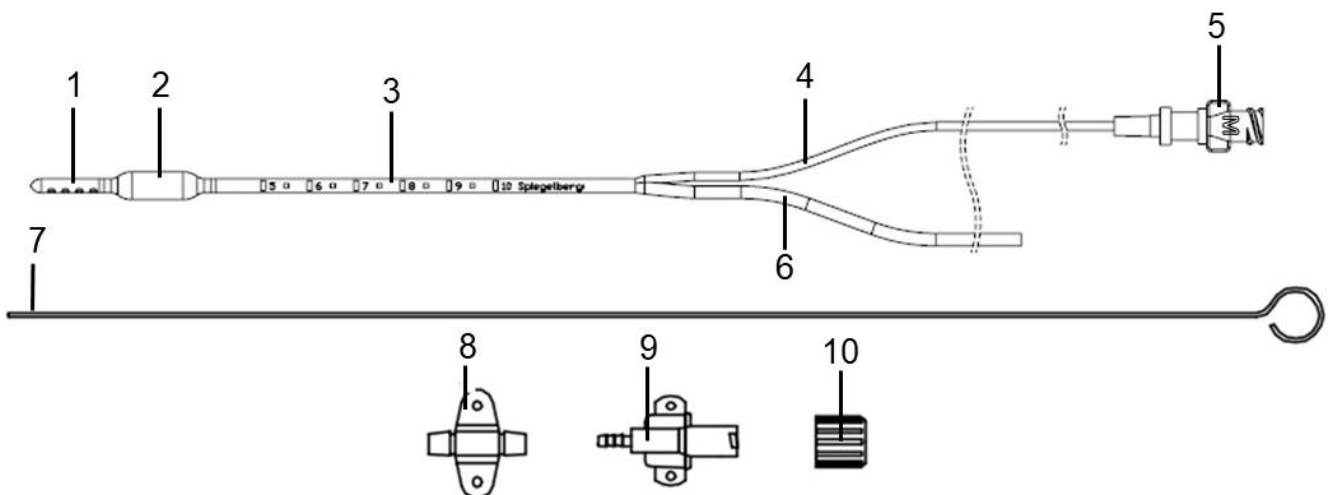

**SND13.1.13/FV532P / SND13.1.13XL/FV533P**



## MRI safety information

Non-clinical testing has shown that the “Intracranial Pressure and Catheter System” is “MR conditional”. A patient with this product can be safely scanned in an MRI system meeting the following conditions:

- static magnetic field of 1.5 - 3 Tesla with
- maximum spatial field gradient of 2,300 G/cm (23 T/m)
- maximum force product of 38,000,000 G<sup>2</sup>/cm (38 T<sup>2</sup>/m)
- theoretically estimated whole body averaged (WBA) specific absorption rate (SAR) < 2 W/kg (Normal Operating Mode).

Under the scanning conditions defined above, the “Intracranial Pressure and Catheter System” is expected to produce a maximum temperature rise of less than

- 2.8 °C (2 W/kg, 1.5 Tesla) with an ambient temperature increase of approximately 1.1 °C (2 W/kg, 1.5 tesla)<sup>1</sup>
- 2.7 °C (2 W/kg, 3 Tesla) with an ambient temperature increase of approximately 0.8 °C (2 W/kg, 3 Tesla)<sup>2</sup>

after 15 minutes of continuous scanning.

In non-clinical tests, the image error generated by the product is around 70.9 mm for the product family worst case<sup>3</sup> when the image is generated using a gradient echo pulse sequence and a 3 Tesla MRI.



### **WARNINGS according to the MRI safety information**

- Patient injuries can occur if the conditions for safe use in rooms designated as MRI environments are not observed.
- Never exceed a maximum whole body averaged (WBA) specific absorption rate (SAR) of 2 W/kg during MRI measurement (Normal Operating Mode).
- The ICP probe must be disconnected from the Spiegelberg ICP monitor before it is brought into rooms designated as MRI environments.
- Make sure that all components of the EVD set used with the ICP probe are “MR Safe” or “MR Conditional” at 1.5 or 3 Tesla.
- Do not bring probe accessories (stylet, 7) into the MRI environment.
- Spiegelberg ICP monitors must never be brought into rooms marked as MRI environments.

<sup>1</sup> RF-related temperature increase for probe 3PS (REF: SND13.1.63/FV535P); worst case on behalf of the whole “Intracranial Pressure and Catheter System” under the aforementioned scanning conditions

<sup>2</sup> RF-related temperature increase for Silverline® ventricular drainage catheter with cranial screw (REF: EVD30.014.02); worst case on behalf of the whole “Intracranial Pressure and Catheter System” under the aforementioned scanning conditions

<sup>3</sup> Determined using the Silverline® ventricular drainage catheter with cranial screw (REF: EVD30.014.02); worst case on behalf of the whole “Intracranial Pressure and Catheter System”.

## Application & handling

### Preparing the ICP probe

The ICP probe should be checked for completeness prior to use.

The insertion depth of the ICP probe should be determined using imaging techniques prior to insertion. Please note that the air chamber (2) must be completely inside the ventricle.



**WARNING!** There is a risk of tissue damage if the ICP probe is inserted too far. In addition, incorrect measured values may be obtained.



**NOTE!** If the printed image on the scale (3) is not clearly legible, another ICP probe must be used.

### Preparation of the application area



**NOTE!** The appropriate insertion site and technique must be selected by the surgeon.

1. Perform aseptic preparation of the surgical area and put up surgical drapes.
2. Open up the scalp.
3. Place the drill hole (minimum diameter: 3.0 mm for Probe 3 or 3.8 mm for Probe 3XL). Clean the drill hole completely to remove any chips, splinters and bone fragments.
4. Incise the dura.
5. Place the cap (10) on the plastic end of the Luer lock connector (9).



**WARNING!** Care should be taken during drilling to avoid drilling too deep and damaging the dura.



**WARNING!** The stylet (7) may not be used to open the dura. This may cause damage to the tissue or to the stylet (7).



**NOTE!** If the drill hole is too small, it will not be possible to insert the ICP probe or insertion will not be possible without causing damage.



**NOTE!** If the drill hole is not cleaned completely to remove any chips, splinters and bone fragments, the air chamber (2) may be damaged when inserting the ICP probe.

### Inserting the ICP probe



**NOTE!** The stylet (7) must be used for the insertion of the ICP probe. Otherwise there is a risk of the tube kinking or rolling up.



**NOTE!** The stylet (7) may only be inserted into the drainage lumen (6), otherwise the filter on the HDM connector (5) will be damaged. This may result in incorrect measured values or the loss of function of the ICP probe.



**NOTE!** The air chamber (2) should be moistened with isotonic saline solution prior to use in order to reduce possible friction.



1. Insert the stylet (7) into the drainage lumen (6).
2. Position the ICP probe in the ventricle.
3. Determine the correct depth using the printed scale (3).
4. Remove the stylet (7).
5. Check the correct positioning based on the flow of cerebrospinal fluid.
6. Push the distal end of the drainage lumen (6) over the entire length of the metal part of the Luer lock connector (9).
7. Secure the ICP probe in place using the butterfly suture clamp (8).



**WARNING!** In the event that the air chamber (2) becomes partially or completely detached from the tube during use, the ICP probe must be replaced and the detached parts removed.



**WARNING!** The stylet (7) must not be inserted into an ICP probe which has already been positioned. This poses a risk of injury! If the stylet (7) is to be reinserted, the ICP probe must be pulled out and reinserted.

## Determining the position of the ICP probe

The position of the ICP probe can be checked using imaging techniques and based on the flow of CSF.



**NOTE!** The correct positioning of the ICP probe and the condition of the patient must be checked at regular intervals.

## Attaching the ICP probe

1. Position the butterfly suture clamp (8) on the double lumen of the ICP probe.
2. Affix the butterfly suture clamp (8) to the patient's scalp.



**NOTE!** The butterfly suture clamp (8) should not be affixed in a straight line to the drill hole. Rather, it should be secured in such a way that the tube forms a semicircle shape.



**NOTE!** The butterfly suture clamp (8) may only be attached to the double lumen, otherwise the ICP probe cannot be attached properly.



**NOTE!** The resulting loop should be covered with a bandage to prevent it from becoming caught on the tube and the ICP probe being pulled out.



**WARNING!** The suture used to attach the butterfly suture clamp (8) must not be overtightened. Otherwise the tube may be constricted, resulting in incorrect measured values or a failure to record measured values.

## Connection to an EVD set

1. Remove the cap (10) from the Luer lock connector (9).
2. Connect the Luer lock connector (9) to the connector on the EVD set.
3. Turn the Luer lock connector (9) until significant resistance can be felt and the connection is secure.
4. Perform a visual check for leaks and function.



**NOTE!** Mixing up the connectors (5, 9) on the ICP probe will result in a leaking connection with the EVD set.

 **NOTE!** Visual checks of the connection to the EVD set must be carried out on a regular basis.

## Connection to the ICP monitor

 **WARNING!** The HDM connector (5) must not be disinfected or moistened, otherwise the filter inside the connector will clog.

 **WARNING!** The HDM connector (5) must be kept dry. Otherwise the ICP probe may lose function or the ICP monitor may be damaged.

1. Connect the HDM connector (5) on the ICP probe to the probe connector on the ICP monitor.
2. Turn the HDM connector (5) clockwise until significant resistance can be felt and the ICP probe is firmly connected to the ICP monitor.
3. Check the display on the ICP monitor and the values for plausibility.

 **NOTE!** The monitor connection, HDM connector (5), is marked with an "M".

 **NOTE!** Mixing up the connectors (5, 9) on the ICP probe will result in a leaking connection with the ICP monitor and may lead to damage to the ICP monitor.

 **NOTE!** The function of the ICP probe can be confirmed by the pulsatile signal on the ICP monitor.

## Checking the function of the ICP probe

1. Use the measured values and the flow of CSF to check the function of the ICP probe.
2. Check the plausibility of the measured values using the pulsatile signal or the amplitude between the systolic and diastolic measured value.

## Drainage of CSF

CSF in the ventricle passes through the drainage holes (1) via the drainage lumen (6) into the EVD set. If there is no flow of CSF, the tube system must be checked for kinks or constriction.

 **NOTE!** Kinks and constriction in the drainage lumen (6) must be avoided to prevent drainage restrictions.

 **NOTE!** Where there is no flow of CSF, this indicates a blockage, kink or constriction. In the event of a blockage, the ICP probe must be replaced.

## Disconnecting the EVD set



1. Turn the Luer lock connector (9) counter clockwise.
2. Quickly cap the Luer lock connector (9) with the cap (10).

## Replacing the EVD set



1. Disconnect the Luer lock connector (9) and the EVD set.
2. Quickly cap the Luer lock connector (9) with the cap (10).
3. Replace the EVD set according to the manufacturer's instructions.
4. Remove the cap (10) from the Luer lock connector (9).
5. Connect the Luer lock connector (9) to the EVD set.

## Closing the wound

After the proper function of the ICP probe has been confirmed, the wound on the scalp can be closed. The technique and material used for this are to be determined by the surgeon.

-  **NOTE! When closing the wound, care must be taken not to damage the ICP probe.**
-  **NOTE! Ensure that the ICP probe is not constricted while closing the wound. Otherwise incorrect measured values may be obtained and the drainage may become blocked.**

## Removing the ICP probe

-  **NOTE! Proceed slowly and carefully when removing the ICP probe. It must be ensured that no tissue is damaged and that the butterfly suture clamp (8) has been detached.**
-  **NOTE! The ICP probe must not be removed in a fast and jerky manner in order to avoid injuries and prevent blood, CSF and possibly tissue from being sprayed around.**
-  **NOTE! The ICP probe must not be pulled over sharp or uneven edges during removal to avoid damaging the tube (3) and thus tearing the ICP probe.**

1. Disconnect the ICP probe from the ICP monitor and from the EVD set.
2. Loosen the fixings attaching the ICP probe to the patient.
3. Pull out the ICP probe.
4. Check that the ICP probe has been removed completely and that the tissue has not been damaged.
5. Observe the condition of the patient.

-  **NOTE! No components of the ICP probe (e.g. the air chamber, 2) may be left in the patient.**

## Disposal

After use, the product should be disposed of in accordance with the regulations for infectious waste and/or in accordance with national or regional regulations.

## Returns policy

Before returning a product, approval must be obtained from the customer service department. Returns will not be accepted unless the return has been approved in advance by Spiegelberg in the context of a complaint or a return has specifically been requested.

Contaminated/used products must be packaged in a bag for biological hazardous substances for return shipment.



**Manufacturer:**  
**Spiegelberg GmbH & Co. KG**  
**Tempowerkring 4**  
**21079 Hamburg**  
**Germany**

**Tel.: +49-40-790-178-0**  
**Fax: +49-40-790-178-10**  
**E-mail: [info@spiegelberg.de](mailto:info@spiegelberg.de)**  
**<http://www.spiegelberg.de>**

Subject to technical changes.

Version: 13 / 2022-06-29



0297

© by Spiegelberg GmbH & Co. KG 2022